



Electric Dropbolt Locks are the most common locks which compatible with virtually any access control system without additional optional brackets and they are available in failsafe and fail-security modes. Fully concealed mounting feature enhanced aesthetic appearance.

Specifications:

- Fail-Safe Version (Power to Lock)
- Power Input: 12 V DC
- Voltage Tolerance: $\pm 10\%$
- Current Draw:
Pull in: 0.9A, Holding: 0.3A@12V DC
(at temperature 20°C)
- Door Position status output (Reed rated 0.25A@30VDC) indicates door opened or closed status.
- Operating Temperature: -10~+45°C
- Humidity: 0~95% non-condensing.
- Lock's surface Temperature (when the power is on):
 \leq current temperature +20°C
- Tested to 500000 cycles.
- Auto-relocking Time Delay : 0, 3 ,6 ,9seconds
- Weight (Approx.) : 1.1 Kg

Double Acting Doors

EB-300 is specially designed for double acting doors. It also can be installed in in-swinging or out-swinging doors.

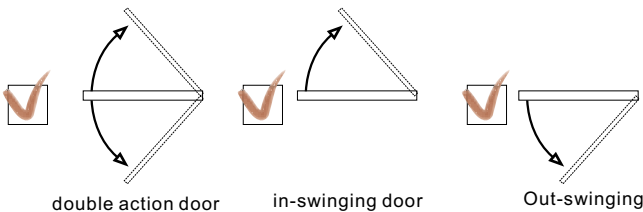

Clamp circuitry

After the bolt projected, the current will drop from 0.9A (the 'pull in' mode) to 0.3A (the holding mode). This design does not only protect the power supply but also extend the lifetime of the Electric Dropbolt Lock.

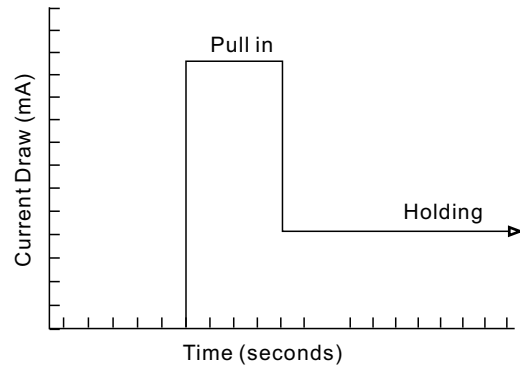

Surface Mount for Narrow Frame

The dropbolt and strike plate with complete housings are specially designed for narrow door frames.

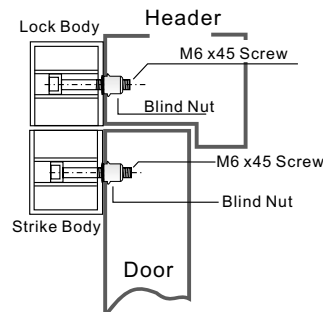

Anti-invade circuitry

The reed detecting function will automatically disconnect after the bolt projected due to the security reason. The vandal resistant circuit design will prevent the misleading action of the Electric Dropbolt Lock caused by manually break up the sense between sensor magnet and the reed.

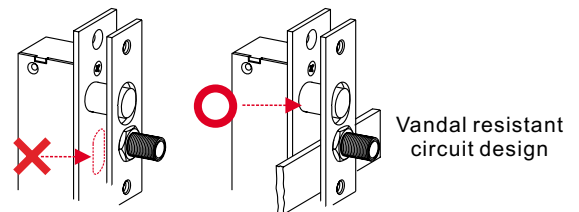



Long life solenoids

Special designed solenoid for strength and long life operating lifetime with guaranteed 500,000 operations.

Horizontal or vertical installation

GEM's Dropbolt series models can be either installed horizontally on the header of the doorframe (Fig. A) or vertically on the side of the door or doorframe (Fig. B).

Solid bolt for superior strength

Greater security is provided by the 16mm diameter (16mm bolt throw) solid stainless steel bolt with hardened magnet core, which has resistant to metal cutting saws. The bolt also rotates freely, making attempts to tamper or cut extremely difficult.

Auto Relocking Timer Setting

Use jumpers to adjust the time between 0 to 9 seconds for door locking time delay. This is the time, which takes the Dropbolt to automatically lock after the door is closed.

Auto Relocking Timer Setting

ON <input type="checkbox"/> 1 <input type="checkbox"/> 2 ↑	ON <input type="checkbox"/> 1 <input type="checkbox"/> 2 ↑	ON <input type="checkbox"/> 1 <input type="checkbox"/> 2 ↑	ON <input type="checkbox"/> 1 <input type="checkbox"/> 2 ↑
0 seconds	3 seconds	6 seconds	9 seconds

(Fig. A) Horizontal Installation

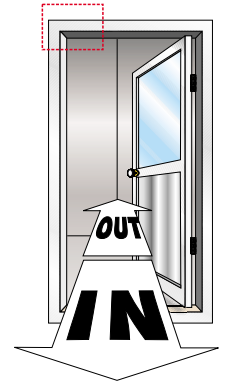
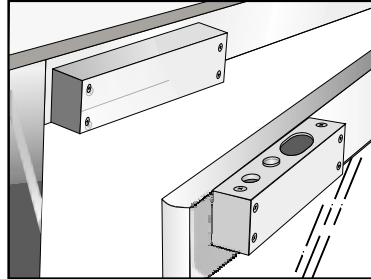

(Fig. B) Vertical Installation

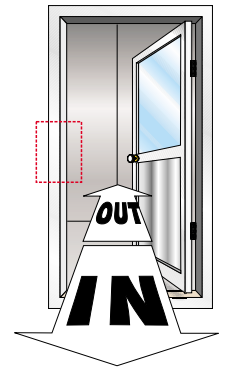
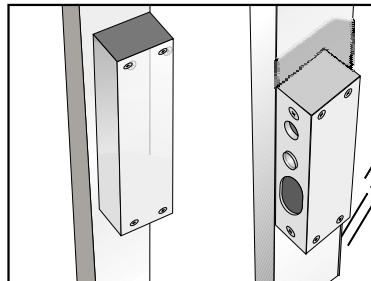

Dimension

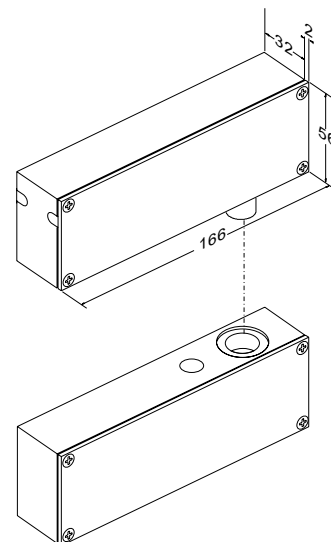

Unit: mm

Warranty

GEM Electric Dropbolts are warranted against defects in material and workmanship while used in normal service for a period of 3 years from the date of sale to the original customer.

Disclaimer

The information and specifications printed in this manual are current at the time of publication. The GEM policy is one of continual development and improvement; therefore GEM reserves the right to change specifications without notice.