



Electric Dropbolt Locks are the most common locks which compatible with virtually any access control system without additional optional brackets and they are available in failsafe and fail-security modes. Fully concealed mounting feature enhanced aesthetic appearance.

Specifications:

- Fail-Safe Version (Power to Lock)
- Power Input: 12 V DC
- Voltage Tolerance: $\pm 10\%$
- Current Draw:
Pull in: 0.9A, Holding: 0.3A@12V DC
(at temperature 20°C)
- Door Position status output (Reed rated 0.25A@30VDC) indicates door opened or closed status.
- Operating Temperature: -10~+45°C
- Humidity: 0~95% non-condensing.
- Lock's surface Temperature (when the power is on):
 \leq current temperature +20°C
- Tested to 500000 cycles.
- Auto-relocking Time Delay : 0, 3, 6, 9seconds
- Weight (Approx.) : 1.2 Kg

Double Acting Doors

EB-200N is specially designed for double acting doors. It also can be installed in in-swinging or out-swinging doors.

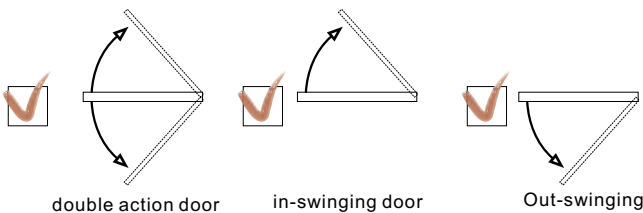

Clamp circuitry

After the bolt projected, the current will drop from 0.9A (the 'pull in' mode) to 0.3A (the holding mode). This design does not only protect the power supply but also extend the lifetime of the Electric Dropbolt Lock.

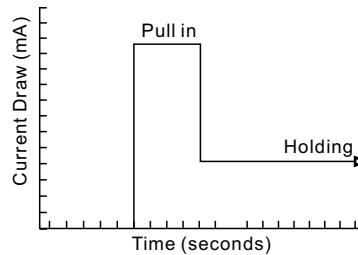

Anti-invade circuitry

The reed detecting function will automatically disconnect after the bolt projected due to the security reason. The vandal resistant circuit design will prevent the misleading action of the Electric Dropbolt Lock caused by manually break up the sense between sensor magnet and the reed.

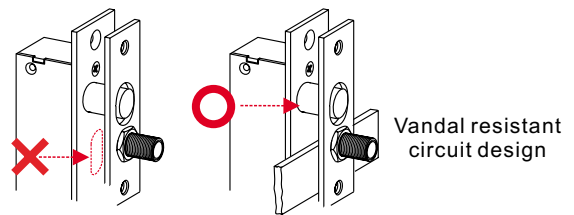

Auto Relocking Timer Setting

Use jumpers to adjust the time between 0 to 9 seconds for door locking time delay. This is the time, which takes the Dropbolt to automatically lock after the door is closed.

Auto Relocking Timer Setting

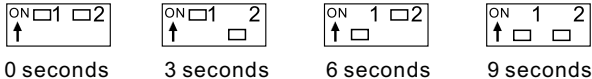

Solid bolt for superior strength

Greater security is provided by the 16mm diameter (16mm bolt throw) solid stainless steel bolt with hardened magnet core, which has resistant to metal cutting saws. The bolt also rotates freely, making attempts to tamper or cut extremely difficult.

Warranty:

GEM Electric Dropbolts are warranted against defects in material and workmanship while used in normal service for a period of 3 years from the date of sale to the original customer.

Disclaimer:

The information and specifications printed in this manual are current at the time of publication. The GEM policy is one of continual development and improvement; therefore GEM reserves the right to change specifications without notice.

GIANNI INDUSTRIES, INC.

No.306-1, Hsin Shu Road, Hsin Chuang, Taipei, Taiwan 242
 TEL: 886-2-2206 9929 FAX: 886-2-2204 6632
 E-Mail: info@gianni.com.tw
 Website: www.gianni.com.tw

Copyright all rights reserved
 DM-CA-2004-EB-200N Ver. A Publish:2005.12.22



The products are manufactured under an ISO 9001 Certified Quality Management Program environment back its product quality, performance and commitment to customer satisfaction.



Long life solenoids

Special designed solenoid for strength and long life operating lifetime with guaranteed 500,000 operations.

Horizontal or vertical installation

GEM's Dropbolt series models can be either installed horizontally on the header of the doorframe (Fig. A) or vertically on the side of the door or doorframe (Fig. B).

Fig. A Horizontal Installation(Frame Header)

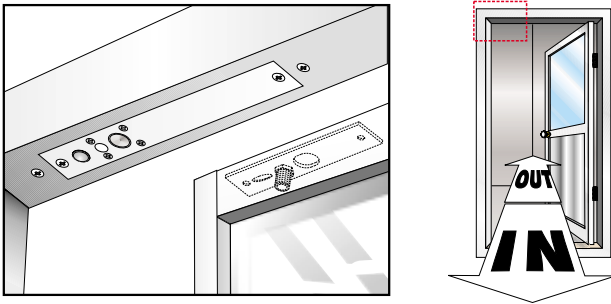
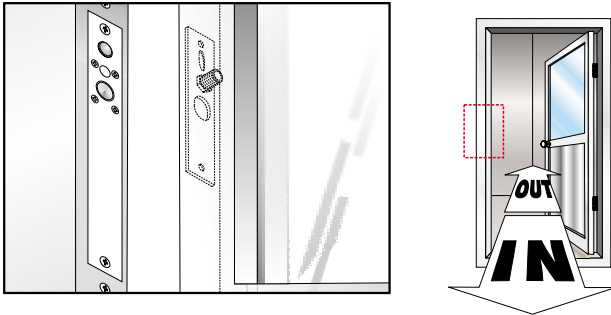
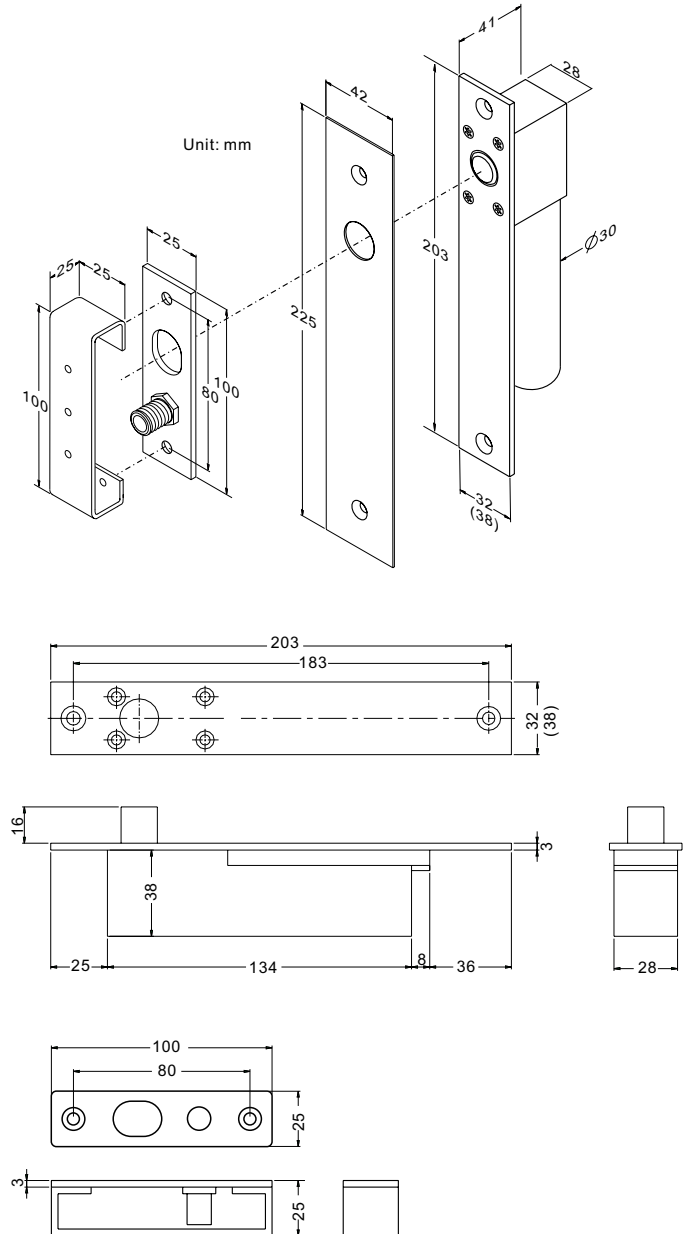

Fig. B Vertical Installation(Side Jamb)



Dimension:



Optional Accessory:

The KR-140 Key Unlatches are also available to install together with Electric Dropbolt Locks, which provide the emergency manual release capability to prevent any unpredictable circumstances that disabled the Electric Dropbolt Locks.(Fig. C)

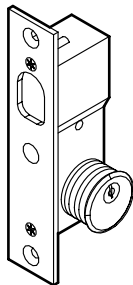

KR-140 key Unlatch
(Cylinder is exclude)

The KR-140 mechanic key release is for unlock electric deadbolt or dropbolt during power failure for safety reasons.

GIANNI INDUSTRIES, INC.

